

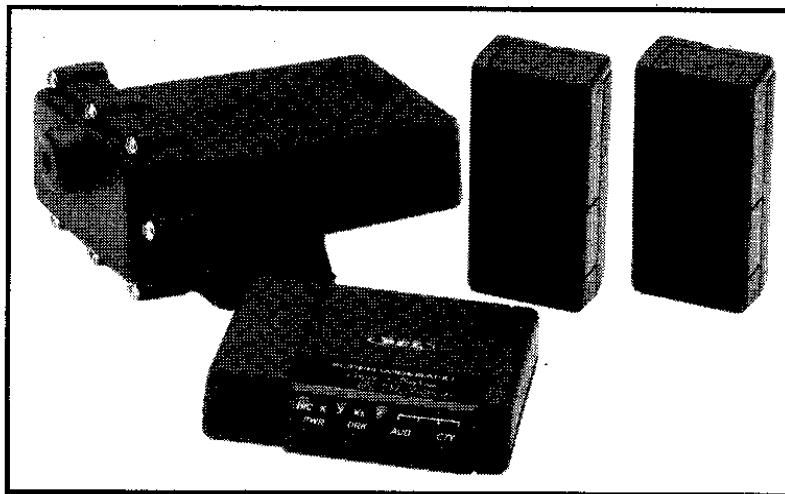

VECTOR LR Remote RADAR • LASER • SAFETY REMOTE DETECTOR

Advanced **PROTECTION** *System*[™]
with Shadow Technology[®] II



Operating instructions for
model 975

 **SWS**
safety warning system

DIGITAL
DIGITAL PLL SYNTHESIZED OSCILLATOR

INTRODUCTION

Thank you for purchasing a BELTRONICS Remote installation Radar/Laser/Safety detector.

Your VECTOR LR Remote detector provides all the benefits of full coverage Radar and Laser detection as well as detection of the Safety Warning System™—all in the discretion of a concealed installation.

To ensure maximum benefit from your new VECTOR LR Remote, please read all operating instructions completely as well as the accompanying installation instructions enclosed.

SHADOW TECHNOLOGY® II

VECTOR LR REMOTE contains Shadow Technology® II, making it undetectable to the Interceptor VG-2 or any other Radar Detector Detector (RDD). Only Shadow Technology® II has been consistently proven undetectable to the Interceptor VG-2.

SELECTABLE FEATURES

1. Auto-Mute On/Off

Select Auto-Mute ON for several X, K, Super Wideband Ka audio alerts followed by a “clicking” tone to quietly inform you for the duration of the signal. Auto-Mute OFF provides a continuous series of X, K, Super Wideband Ka audio alerts. Factory setting is Auto-Mute OFF. (see page 9)

2. Safety Warning System® (sws™)

VECTOR LR Remote detects encoded signals from sws™ transmitters and provides distinct alerts for: Highway Construction / Maintenance, Highway Hazard Zones, Weather Related Hazards, Emergency/Slow Moving Vehicles and Travel /Convenience Information.

For a complete description of sws™ audio and visual alerts, see page 16.

3. X/K/Ka Band On or Off

Select “X ON/X OFF”, “K ON/K OFF” or “Ka ON/Ka OFF” depending upon your driving environment and selectivity requirements. Factory setting is X/K/Ka ON. (see page 9).

4. Four Ka Narrow Frequencies

Select Ka Narrow sweeps of 33.8 GHz, 34.36 GHz, 34.7 GHz or 35.5 GHz. Narrow Band Ka frequencies are especially useful in areas where you know a specific Ka Narrow sweep is used. Factory setting is Super Wideband Ka ON. (see page 9)

TABLE OF CONTENTS

Profile of Features	▶ <i>page 4</i>
Description of Features	▶ <i>page 5</i>
Power-on Test Sequence	▶ <i>page 5</i>
Tutorial Mode	▶ <i>page 6</i>
Low Voltage Warning	▶ <i>page 6</i>
Loss of Antenna Connection	▶ <i>page 6</i>
Memory Retention of Feature Selections	▶ <i>page 6</i>
Adjusting the Audio Level	▶ <i>page 6</i>
Audio/Visual Alert for Instant-On/Pulsed Radar	▶ <i>page 7</i>
DRK (Dim/Dark) Button	▶ <i>page 7</i>
AUD (Audio -Mute/Volume Control) Button	▶ <i>page 7</i>
CTY (City/Highway) Button	▶ <i>page 8</i>
City X/K/Ka Mode	▶ <i>page 9</i>
Reset to Factory Settings	▶ <i>page 9</i>
Selectable Features	▶ <i>page 9</i>
Entering Selectable Features Mode	▶ <i>page 10</i>
Understanding Radar, Laser and sws™	▶ <i>page 11</i>
Interpretation of Alerts	▶ <i>page 12</i>
Radar Alerts	▶ <i>page 12</i>
Typical False Alert	▶ <i>page 15</i>
Laser Alerts	▶ <i>page 15</i>
Safety Warning System® (sws™) Alerts	▶ <i>page 16</i>
Performance Verification	▶ <i>page 17</i>
Troubleshooting	▶ <i>page 18</i>
Consumer Warranty	▶ <i>page 19</i>
Service	▶ <i>page 20</i>
Warranty Service	▶ <i>page 20</i>
Post-Warranty Service	▶ <i>page 20</i>
Specifications	▶ <i>page 21</i>
Accessories	▶ <i>page 22</i>

PROFILE OF FEATURES

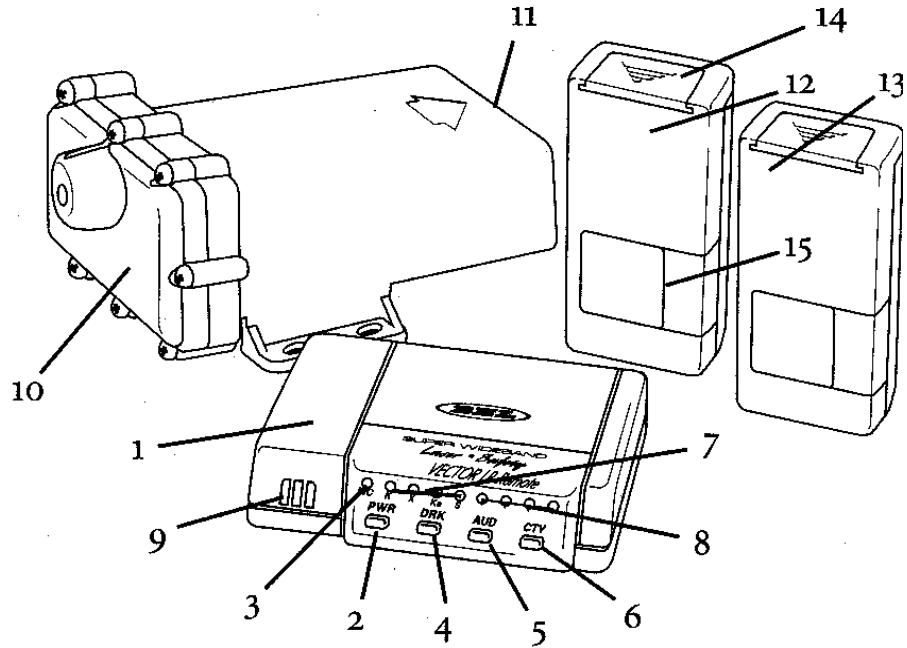

1. **Remote Control Panel Unit:** compact design fits discretely and easily in any vehicle.
2. **PWR (Power) Button:** pressing PWR briefly will turn the unit ON. Pressing PWR a second time will cancel the power-up test sequence.
3. **H/C (Highway/City) Indicator:** illuminates green for highway mode, and amber for City X mode. City X/K/Ka is confirmed by the flashing green/amber LED, followed by solid illuminator of the amber LED.
4. **DRK (Bright/Dim/Dark) Button:** provides dim or dark settings of the LED display for discreet night travel. Audio alerts are not affected by this mode.
5. **AUD (Audio Mute) Button:** provides manual muting of X, K, Super Wideband Ka Radar and sws™ alerts. Pressing and holding the AUD button will change the audio level.
6. **CTY (City/Highway) Button:** minimizes unwanted X band alerts without reducing sensitivity. City X/K/Ka reduces falsing on all three bands.

7. **K/X/Ka/sws™ Band Visual Alerts:** the alert received is confirmed by the illumination of the appropriate LED.
8. **Four-LED Display:** LEDs illuminate sequentially to confirm the signal strength of Radar signals. A different alert pattern confirms detection of Laser and Safety Warning System® (sws™).
9. **Audio Speaker:** all audible alerts are emitted from this location.
10. **Antenna Sensor:** contains the electronics which detect police Radar. This antenna sensor installs within the engine compartment of the vehicle.
11. **Antenna Face:** receiving portion of the antenna sensor must have a clear, unobstructed view of the road ahead.
12. **Front Laser Sensor:** with 11' cable mounts onto the windshield using the supplied suction cup.
13. **Rear Laser Sensor:** with 17' cable mounts to rear window of vehicle.
14. **Windshield Accessory Cover:** remove the cover to insert the suction cup mount.
15. **Optical Opening:** Laser signals are received at this side of the Laser sensor which must have a clear, unobstructed view of the road ahead.

DESCRIPTION OF FEATURES

Power-on Test Sequence

Each time your unit is turned on, alerts for Laser, X, K, Ka and Safety Warning System™ are presented briefly. This is immediately followed by the status of the four Selectable Features:

1. **Auto Mute** - a clicking tone confirms if feature is engaged.
2. **Safety Warning System®** - illumination of the green "S" LED confirms if feature is engaged.
3. **X/K/Ka Bands** - illumination of the appropriate LED confirms if band is activated. Full illumination of four signal strength LED, coupled with the illumination of the Ka LED confirms Super Wideband Ka mode.

-
- 4 **Ka Narrow Bands** — With Super Wideband Ka turned OFF, any Ka narrow frequency which is engaged is confirmed by rapid flashing of appropriate signal strength LED (see page 10).

Pressing PWR anytime during the power up test sequence will suspend the normal power up test sequence; your unit will be ready for operation.

Tutorial Mode

The tutorial mode allows you to become more familiar with all audible and visual alerts. To engage this mode, press the **AUD** and **CTY** buttons simultaneously while the unit is **ON**. The audio/visual alerts will be presented slowly in order of Laser, K, X, Ka and sws™. The tutorial mode will cycle these audio/visual alerts continuously. Press the **P/V** button to exit. Two “beeps” confirm exiting from the tutorial mode. Your unit is now **ON** and ready for operation.

Set and Forget Memory

Any time **VECTOR LR Remote** is turned OFF all feature settings you have selected are retained in the unit’s memory. Set and Forget Memory eliminates the need to reset your preferred feature settings each time your unit is turned OFF and then back ON.

Low Voltage Warning

VECTOR LR Remote continually checks voltage to ensure proper performance. The unit’s operating range is 10.0 to 16.0 volts. If voltage falls below 10.0, the highway (**H**) or city (**C**) indicator will flash, coupled with a series of steady audible “beeps”.

Loss of Antenna Connection

In the event the control panel and Radar antenna are not properly connected, the X/K/Ka band indicators will flash, coupled with steady audible “beeps”.

Audio/Visual Alert for Instant-On/Pulsed Radar

This type of signal appears suddenly when a Radar unit is “triggered”. The instant-on or pulsed alert consists of an intense, three-second, X, K or Super Wideband Ka audio “burst”, coupled with the a flashing of the four-LED display.

DRK (Bright/Dim/Dark) Button

The DRK button allows selection of a dim or dark setting for all LEDs. To engage dim mode, press the DRK button once. A single “beep” confirms your selection. To completely cancel the illumination of all LEDs, press DRK a second time. You’ll notice the city/highway LED remains dim to confirm your unit is receiving power. To return to a full bright setting, press the DRK button a third time; two “beeps” confirm this selection. Use of the DIM button does not affect audio alerts.

Important—if you press the DRK button and do not receive audible confirmation, the audio level has been set too low.

AUD (Audio Mute/Volume Control) Button

Manual Muting of Audio Alerts (Radar and sws™)

Whether Auto-Mute is selected ON or OFF in Selectable Features, the audio alerts can be completely muted by pressing the AUD button during an alert. No audible alert will be heard for approximately 12 seconds. If the signal is still present after 12 seconds, the unit will remain in manual mute mode.

Volume Control

Press and hold the AUD button to engage the volume control. Release the AUD button when you have reached your desired audio setting. To reverse direction of the volume, release and press AUD a second time.

Note—because Laser alerts are not lengthy or sustained, muting is not required (see page 17)

CTY (City/Highway) Button

The City X mode has been designed to effectively reduce unwanted audio alerts caused by intrusion alarms, door openers, and other devices which share X band with police Radar—without reducing sensitivity. Signals from non-police Radar sources are frequently encountered in urban and suburban areas, making use of this mode ideal in these areas.

Pressing the CTY button once engages the City X mode which is confirmed by a single “beep” and the illumination of the yellow city LED labeled H/C. Once engaged, weak X band signals encountered will produce no audible alert until the signal strength reaches a preset level. However, visual alerts are processed the instant an X band signal is detected, keeping you quietly informed. Since most “false” X band signals are weak, the use of the city mode allows you to drive out of their range before they reach the preset level and trigger a full audio alert. In contrast, signals from X band traffic Radar are generally stronger and will exceed the preset level, causing a full X band audio alert.

Activating the City X mode will not change Super Wideband Ka, K or instant-on X band Radar alert patterns.

Note—the city mode has no effect on the reception of Laser or sws™.

City X/K/Ka

City X/K/Ka provides an alternate approach for improving X, K and Ka band selectivity and is ideal for use in areas with a high level of microwave transmissions which can cause falsing on all three bands. To engage City X/K/Ka mode, press the City button twice. City X/K/Ka is confirmed by the alternate flashing of the green/amber H/C LED for one second. After the one second, the LED returns to solid amber illumination.

Once engaged, weak X,K or Super Wideband Ka signals encountered will produce no audible alerts until the signal strength reaches a preset level. Visual alerts are processed the instant an X,K or Super Wideband Ka signal is detected, keeping you quietly informed.

Pressing CTY a third time returns you to highway mode; two beeps and the illumination of the green H/C LED confirms highway mode.

Reset to Factory Settings

You can reset your unit to factory settings for volume, DRK, AUDIO, CITY and Selectable Features. With the unit OFF press and hold the AUD and CTY buttons, then press the PWR button. Two “beeps” will confirm factory settings are reset. Your unit is now ON and ready for operation.

SELECTABLE FEATURES

Auto-Mute, Safety Warning System[®], X/K/Super Wideband Ka ON/OFF and the four Ka Narrow frequencies: 33.8 GHz, 34.36 GHz, 34.7 and GHz, 35.5 GHz, are all features that may be selected ON or OFF, depending upon your preference.

Auto-Mute On/Off

When activated, unit will provide several X,K, Super Wideband Ka audio alerts followed by a “clicking” tone to keep you quietly informed for as long as the signal is present. This clicking becomes more rapid as the strength of the Radar signal increases. Auto-Mute enables you to conveniently monitor extended encounters without having to manually mute or adjust the volume setting.

Note-because of their urgency, Laser alerts are not affected.

With Auto-Mute off, unit will provide a continuous series of X, K, Super Wideband Ka or Laser audio alerts. This standard setting is often preferred when background noise in a vehicle is loud. Factory setting is Auto-Mute off. Auto-Mute ON is confirmed by the FULL illumination of all 4 red LEDs in the signal strength meter. Auto-Mute off is confirmed when the same 4 red LEDs flash.

Safety Warning System® (SWS™)—LED #1

When activated, unit will detect signals from sws™ transmitters and provide audio/visual warnings if sws™ transmitters are in use. Factory setting is ON.

X Band On/Off—X BAND LED

When activated, unit will detect X Band signals (10.456 GHz - 10.60 GHz).

K Band On/Off—K BAND LED

When activated, unit will detect K Band signals (24.050 GHz - 24.250 GHz).

Super Wideband Ka On/Off—KA BAND LED

When activated, unit will detect Super Wideband Ka signals (33.4 GHz-36.0 GHz).

Ka Narrow Band (33.8 GHz) On/Off (LED #1)

When activated, unit will detect ONLY the 33.8 GHz segment of the Ka bandwidth.

Ka Narrow Band (34.36 GHz) On/Off (LED #2)

When activated, unit will detect ONLY the 34.36 segment of the Ka bandwidth.

Ka Narrow Band (34.7 GHz) On/Off (LED #3)

When activated, unit will detect ONLY the 34.7 GHz segment of the Ka bandwidth.

Ka Narrow Band (35.5 GHz) On/Off (LED #4)

When activated, unit will detect ONLY the 35.5 GHz segment of the Ka bandwidth.

Note: Always operate your unit in Super Wideband Ka unless you are certain a specific Ka Narrow band is used in your area of travel. When engaging one, two, three or all four Ka Narrow bands, remember to disengage Super Wideband Ka. If you do not, Super Wideband Ka will override any or all Ka Narrow bands that you have engaged.

Entering Selectable Features Mode

1. With the unit OFF, press and hold the CTY button followed by the PWR button. A short “beep” will sound indicating you’re in Selectable Features mode.
2. Illumination of the appropriated LED confirms feature is ON. Conversely, if the selected LED is flashing, the feature is OFF.
3. Feature selection is made by pressing the CTY button to move forward in the list of Selectable Features; pressing DRK moves backward in the list. Selectable Features appear in the following order and are identified as follows:
 - Auto-Mute — all signal strength LED’s illuminate.
 - SWS — “S” LED
 - X Band — “X” LED
 - K Band — “K” LED
 - Super Wideband Ka — “Ka” LED
 - Ka Narrow 33.8 — first red Signal Strength LED

- Ka Narrow 34.3 — second red Signal Strength LED
 - Ka Narrow 34.7 — third red Signal Strength LED
 - Ka Narrow 35.5 — fourth red Signal Strength LED
4. Full illumination of the LED confirms feature is ON. Flashing of the LED confirms feature is OFF. Use the AUD button to make your selection.
 5. Press the PWR button to retain your new settings for Selectable Features. Two “beeps” will confirm that you have exited from Selectable Features. Your unit will be ON and ready for operation.

UNDERSTANDING RADAR, LASER AND SWS™

Three Radar Frequencies

Three microwave frequencies have been allocated by the FCC (Federal Communications Commission) and are used for traffic Radar. They are:

X band: 10.45 - 10.60 GHz

K band: 24.050 - 24.250 GHz

Super Wideband Ka: 33.4 GHz to 36.0 GHz

Both X and K bands are well known to motorists who have traveled with Radar detectors. Introduced first was X band Radar which became common during the 1960s. In the mid 1970s, the lower powered, more difficult to detect K band Radar was introduced. In 1987, FCC approval was given for use of Radar equipment using a third frequency, Ka. In response to this, BELTRONICS introduced the first Radar detectors capable of detecting X, K and Ka band signals. In late 1990, FCC approval was given to Wideband Ka: 34.2 GHz to 35.2 GHz. Once again, BEL responded with Wideband Ka detection. Today, your VECTOR LR Remote detects the entire Super Wideband Ka frequency allotted for police monitoring—33.4 to 36.0 GHz, as well as four specific Ka Narrow frequencies.

Safety Warning System™ (sws™)—What is it?

The Radio Association Defending Airwave Rights, Inc. (R.A.D.A.R) conceived and developed the Safety Warning System™. The concept behind this system is to warn motorists of potential road hazards by employing Safety Warning System transmitting devices in areas such as construction zones, accidents sites and detours. Because these sws™ transmitters operate within the 24 GHz portion of the K band frequency, their signals are detected by your unit.

INTERPRETATION OF ALERTS

Radar Alerts

The alerts provided by your unit are affected both by the type of transmission (continuous wave or instant-on) and the position of the Radar source. Generally, when you drive closer to a Radar source the intensity of the received signals increases, resulting in a greater number of LEDs illuminating in the four-LED display (l to r) and a corresponding increase in the audio alert rate. Described on the following pages are five common types of Radar encounters and the alerts you will typically receive.

1. *Stationary or moving Radar, straight ahead aimed in your direction.*

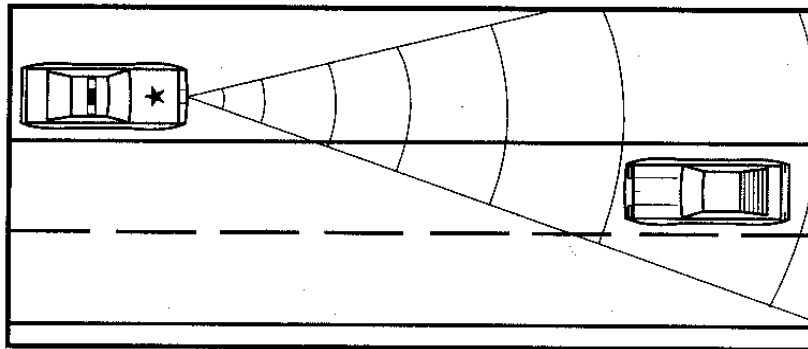

Since Radar signals travel in a straight line, this Radar encounter potentially offers maximum warning range. Once this signal is received, the initial warning consists of the X, K, or Super Wideband Ka audio and visual alerts and the simultaneous illumination of one or more of the LEDs in the four-LED display. The actual number displayed will depend upon the strength of the signal received. As the strength of the Radar signal increases, the audio alerts become more rapid and more LEDs in the display will illuminate. Assuming the Radar signal remains uninterrupted, the audio and visual alerts will clearly indicate a “weak” signal becoming stronger as you drive closer to the Radar source. Remember, when the police Radar source is moving toward you, the Radar signal strength will increase much more rapidly than if you are approaching a stationary source.

2. *Stationary Radar aimed around a corner.*

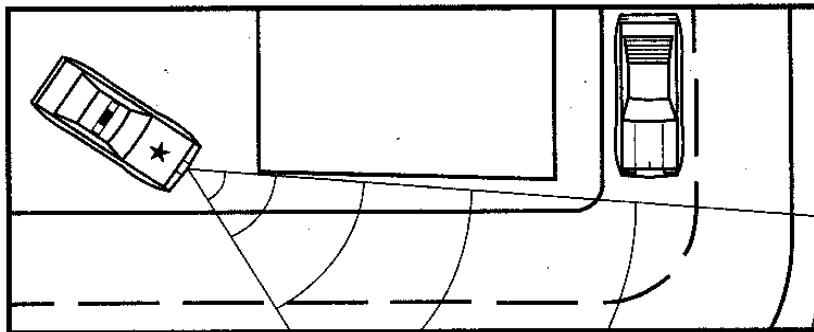

Under this circumstance, reaction time is considerably reduced. Since the Radar signals are transmitted across your line of travel, there is generally no signal available to receive until you are relatively close to the source. Once an alert is received, expect the strength of the signal to increase very quickly. Advanced warning in this situation may be reduced.

3. *Stationary Radar concealed by the crest of a hill aimed in your direction.*

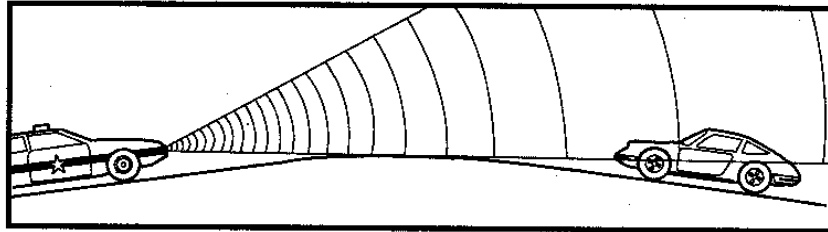

Radar signals travel in a straight line and do not pass through earth. Consequently, police Radar aimed at the crest of a steep hill cannot be received until you are at or near the top. Warning time may be minimal (as in situation #2) since a strong signal is not present until you are near the crest of the hill. At this point, you may be nearly in the police officer's line of sight. When cresting a hill, a weak initial alert followed very quickly by a full alert is typical. This alert pattern requires prompt attention.

4. *Moving Radar behind you, traveling in the same direction.*

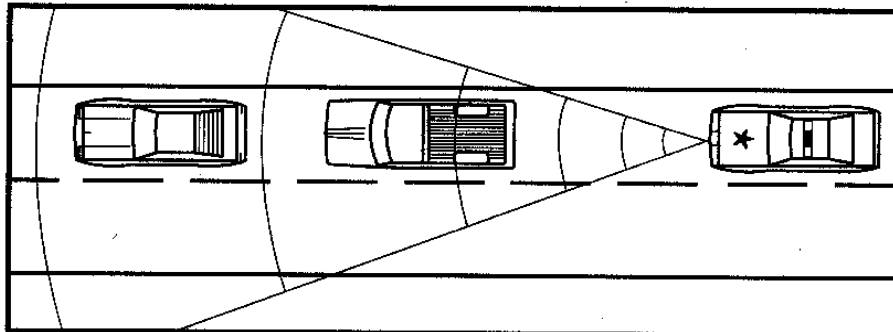

Police Radar signal transmitted from behind your vehicle can be received when reflected by objects in front of you such as large signs, bridges and trucks. As you drive, the size and configuration of these objects are constantly changing, causing the strength of any reflected Radar signal received to vary. A strong, uninterrupted alert indicates the patrol car is close behind.

5. *Instant-on/Pulsed Radar*

If you are the target vehicle, an alert caused by instant-on or pulsed Radar will be strong and immediate. When encountered, your unit responds with a three-second audio/visual warning.

Typical False Alert (Radar)

Ideally, a Radar detector should only alert in the presence of police Radar. However, because other devices share X and K bands with police Radar, false alerts sometimes occur. Generally, a false signal produces only a short audio and visual alert. Since they are most often weak, it is possible to drive out of the signal's range very quickly and receive only a brief alert. Although many times the probable source of the false signal can be identified (supermarket, bank, commercial building, etc.), caution is advised until the source can be confirmed. The X band alert pattern caused by a non-police source can look like the initial alert produced by actual police Radar. For this reason, appropriate action is required any time an alert is received.

Laser Alerts

When Laser is detected, the four-LED display will illuminate in a distinct pattern. This illumination pattern occurs rapidly and is coupled with the distinct Laser audio alert.

If a vehicle is a long distance from the source of Laser pulses, fewer pulses will generally be received. The closer the vehicle is to the source of Laser pulses, the greater the likelihood of receiving a steady stream of Laser pulses. The reason for this is the aiming stability of the Laser gun and the fact that it is impossible to hold the gun absolutely still. Any movement of the gun results in motion of the beam at the target. The further the target, the greater the displacement of the beam and the shorter the dwell time of the beam at the target point. Therefore, there is the possibility of receiving only a few Laser pulses.

Due to these characteristics, all Laser alerts received from your unit should be taken seriously.

Safety Warning System® (sws™) Alerts

With the Safety Warning System™ feature ON and an sws™ transmitter in use, your detector will provide a unique, three-second, two-tone “beep” followed by clicking, coupled with the flashing of the (s) LED and the appropriate LED in the four-LED display. To select SWS™ ON or OFF, see *Selectable Features*, page 9.

*LED #1 confirms Highway Construction/
Maintenance ahead*

*LED #2 confirms Highway Hazard Zone Advisory
which could indicate an accident ahead*

*LED #3 confirms Weather Related Hazards such as
fog ahead*

*LED #4 confirms Emergency/Slow Moving Vehicles
in transit*

When only the sws™ audio warning is provided, the category referenced is Travel/Convenience Information or the category is unknown.

PERFORMANCE VERIFICATION

Conditions that Affect Radar Alerts

If you feel your unit is not alerting properly, keep in mind that there are many conditions that influence the intensity or duration of an alert:

1. The police are using instant-on/pulsed Radar, in which case no signal is transmitted until visual contact has been made with your vehicle. For detection of this signal, you must rely on reflected signals from Radar directed at traffic traveling ahead of you.

2. The police Radar unit is positioned perpendicular to the road, around a curve, or just over the crest of a hill, thus, significantly reducing the reception range.
3. The highway traffic between your vehicle and the police Radar source is heavy, blocking or reflecting transmitted signals. The presence of several large trucks between you and the police Radar unit could also significantly reduce reception.
4. Rain or humid weather conditions can absorb transmitted signals before they reach your vehicle, again reducing detection range.
5. The police Radar unit is not properly tuned and is transmitting outside allocated X, K or Super Wideband Ka frequency ranges.

Conditions that Affect Laser Alerts

If you feel your unit is not properly alerting to the presence of Laser signals, keep in mind that rain, fog, high humidity and other weather conditions can affect the range that the Laser beam can be detected.

TROUBLESHOOTING

Solutions for Common Problems

If your unit is not operating properly, please refer to the outline on the next page.

Problem	Possible Cause	Corrective Procedure
Unit not receiving power	Cable not properly connected to antenna or control panel	Check connection
	Fuse in red power lead is defective	Replace with 1 amp, 250 3AG fuse
"Poor" detection range	Antenna opening partially blocked.	Reposition antenna with unobstructed view of road ahead. Clean off any accumulated debris on antenna face.
Unit alarms every second	Connection to antenna sensor is disengaged	Re-connect cable to antenna sensor
Erratic or frequent alerts	High concentration of non-police X band sources	Use city mode. Review section in this manual on <i>Performance Verification</i> .

If you experience a problem with your unit that is not covered in the previous outline, please call, Monday to Friday, 9 AM–5 PM, EST, for assistance:

1-800-341-2288 USA
1-800-268-3994 CANADA

CONSUMER WARRANTY

Limited One-Year Warranty

1. This warranty covers all defects in materials and workmanship. This warranty does not apply if the unit has been subject to physical abuse, improper installation, modification, or if the housing or serial number of the unit has been removed.
2. BELTRONICS manufactures its products using parts and components which are new or equivalent to new in accordance with industry standard practices.
3. The enforceability of this warranty is limited to the

original consumer purchaser and is not transferable to or enforceable by, any subsequent owner.

4. In the event of a defect, malfunction or other failure to conform to this warranty, BELTRONICS will, at its sole discretion, repair or replace the unit at no charge. You are responsible for all shipping costs in connection with warranty service pursuant to this warranty.
5. This warranty commences on the date of retail purchase and shall be effective for a period of one year.
6. There are no express warranties covering the unit other than those set forth in this warranty. All implied warranties are limited to the one-year period of this warranty and no warranties, expressed or implied, extend beyond this one-year period. Some states do not allow limitation on how long an implied warranty lasts, so the above limitation may not apply to you.
7. BELTRONICS will in no event be liable for any consequential, incidental, indirect or special damages (including, but not limited to, lost profits) arising out of or in connection with the use, misuse or function of the unit. Some states do not allow the exclusion or limitation of incidental or consequential damages, so the above limitation or exclusion may not apply to you.
8. This warranty gives you specific legal rights and you may also have other rights which vary from state to state.
9. You must provide a copy of a dated sales receipt for your unit in order to receive service under warranty.

SERVICE

Warranty Service

If you feel your detector is not functioning properly please review this manual, particularly the section on *Performance Verification*. If you still feel service is required, please follow the instructions below:

1. To obtain service during the one-year warranty period, **please call the appropriate number below to obtain a Return Authorization (RA) Number and the proper mailing address.** Clearly mark the RA number on the exterior of a suitable mailing package before sending your detector, postage paid and insured.
1-800-341-2288 **USA**
1-800-268-3994 **CANADA**
2. For your own protection, obtain a proof of delivery receipt. Shipping costs are your responsibility.
3. Enclose with your unit the following information:
 - (a) Your name, complete return address and written description of the problem (no P.O. BOX please).
 - (b) A telephone number where you can be reached during regular business hours.
 - (c) **A copy of your dated sales receipt.**

Post-Warranty Service

The following arrangements apply if the one-year warranty period has expired or you are not able to provide a copy of your dated sales receipt indicating purchase within the past twelve months.

1. Return your unit to the appropriate address under *Warranty Service* and follow steps 1 through 3(b) outlined in that section.
2. Enclose with your unit \$85 US or \$115 CAN to cover inspection and postage return.

SPECIFICATIONS

Radar Receiver Frequencies: 10.525 GHz \pm 50 MHz (X band), 24.150 GHz \pm 110 MHz (K band), 33.4 GHz to 36.0 GHz (Super Wideband Ka), Ka Narrow: 33.8 GHz, 34.36 GHz, 34.7 GHz, 35.5 GHz.

Laser Wavelength: 905 nm

Operating Temperatures: -4°F to 158°F (-20°C to 70°C)

Power Supply Requirements: 10.0 TO 16.0 Volts,
250 mA

Radar Antenna Type: patented diecast horn with
integrated transition to microstrip mixer

Weight: 7.0 ounces (Antenna Sensor), 3.0 ounces
(Control Panel), 1.8 ounce (Laser Sensor)

Maximum Dimensions

3.66"(L) X 3.14"(W) X 1.77"(H) (Antenna Sensor)

2.25"(L) X 2.0"(W) X .66"(H) (Control Panel)

2.62"(L) X 1.24"(W) X .72"(H) (Laser Sensors)

BELTRONICS reserves the right to incorporate design improvements which may not
be reflected in the specifications listed in this owner's manual.

ACCESSORIES

If you require any additional accessories, replacement
accessories or any accessory which is not included with
your unit, call to order or for more information,
Monday to Friday, 9 AM-5 PM, EST.

1-800-341-2288 USA

1-800-268-3994 CANADA

DESCRIPTION	MODEL NUMBER	COST USA	COST CANADA
Radar Antenna Control Panel	975	\$170.00	\$300.00
In-Dash Mounting Kit Control Panel	DA-55	\$ 8.50	\$12.00
Mounting Kit CONTROL LR Remote	DA-56	\$ 8.50	\$12.00
Control Panel	DA-504	\$67.00	\$93.00

Rear Laser Sensor	DA-915-R	\$50.00	\$70.00
Front Laser Sensor	DA-915-F	\$50.00	\$70.00
Antenna Mounting Kit	DA-82	\$13.00	\$18.00
Antenna Reflector	DA-83	\$10.00	\$14.00
Owner's Manual	975	N/C	N/C



Head Office
2422 Dunwin Drive
Mississauga, Ontario
Canada L5L 1J9
1-800-341-2288 USA
1-800-268-3994 CAN
www.beltronics.com

This product is subject to one or more of the following patents:

U.S.P. #4,571,593	C.P. #1,187,586
#4,630,054	#1,187,602
#4,961,074	#1,295,714
#4,952,936	#1,295,715
#5,402,087	
#5,446,932	Other Patents Pending

Safety Warning System L.C.—Patents Pending

 , Fundamental Mixer Technology and FMT are registered trademarks of BELTRONICS. VECTOR LR, Total Tracking Laser and TTL are trademarks of BELTRONICS. Safety Warning System and sws are trademarks of Safety Warning System L.C.

Printed in Canada 273004-08